

_ TIGER·TEC® SILVER – ISO P GENERATION

More power
in steel turning



Tiger-tec® Silver





TURN PERFECTLY WITH
THE RIGHT AMOUNT OF BITE



2 Tiger-tec® Silver – ISO P Generation

- 2 The new technology
- 6 Geometry/cutting material overview
- 10 Application examples

16 Designation key

18 Walter Select turning tools

20 Extract from ISO P Generation range

- 20 FP5 geometry
- 22 MP3 geometry
- 24 MP5 geometry
- 26 RP5 geometry
- 28 NRF geometry
- 30 NRR geometry

32 Technical information

- 32 Cutting data for turning
- 34 Cutting tool material application tables
- 36 Geometry overview
- 50 Tool life
- 51 Surface finish quality
- 52 Hardness comparison table
- 53 Turning calculation formulae
- 54 Wear patterns

Walter Tiger-tec® Silver – ISO P Generation: The new technology

NEW CUTTING MATERIALS, NEW GEOMETRIES: MORE FORCE, MORE PRECISION

By combining new cutting materials and new geometries, we have created a new generation: the **Tiger-tec® Silver ISO P Generation**. We combined our unique **Tiger-tec® Silver CVD** coating with a brand new type of universal geometry

family for machining steel. The result is inspirational: The **Tiger-tec® Silver ISO P Generation** delivers increases in output of up to 75% in the turning of steel.

NEW: Aluminium oxide with optimised microstructure
+50% higher tool life under conditions of crater wear,
reduced machining time

NEW: Microedge technology
+ 30% longer tool life under
conditions of flank face wear
or plastic deformation

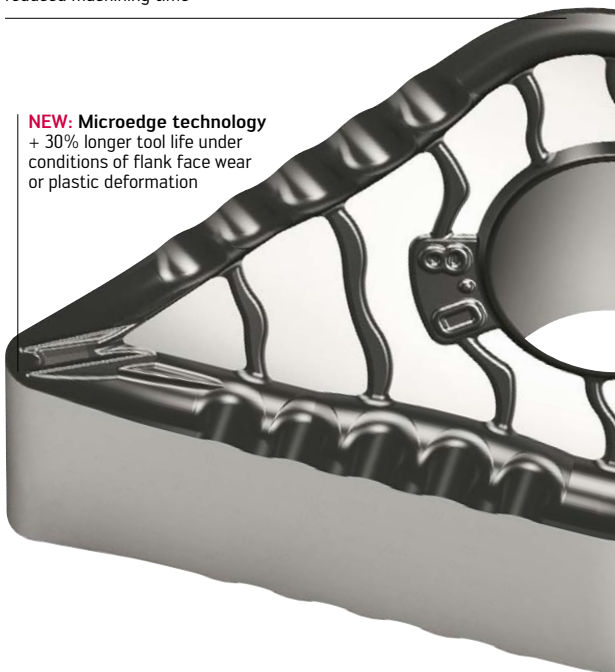

Up to
75%
increase in
output

Tiger-tec® Silver



NEW: Mechanical post-treatment

Unique residual stress state,
increased process reliability in
mass production especially where
interrupted cuts are involved

NEW: ISO P geometries

Large universal breaking area
which allows the diversity of
indexable inserts to be reduced

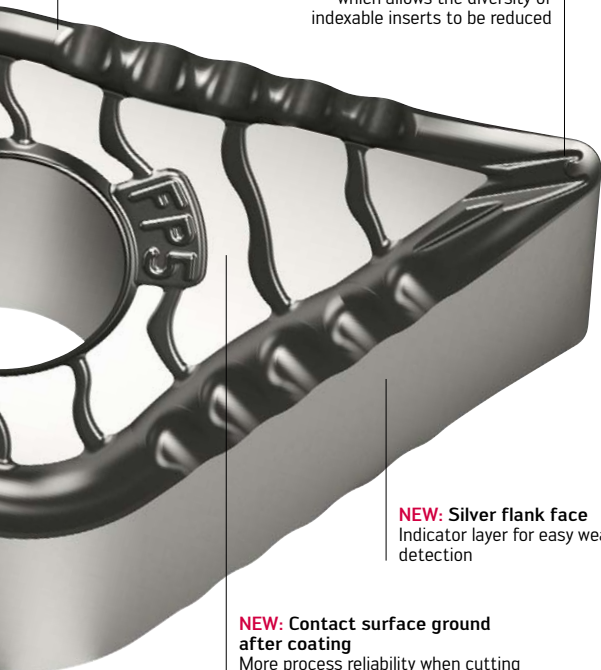

NEW: Silver flank face

Indicator layer for easy wear
detection

**NEW: Contact surface ground
after coating**

More process reliability when cutting
is interrupted

Walter Tiger-tec® Silver – ISO P Generation: Wide range of applications

TIGER-TEC® SILVER: EXTREMELY FLEXIBLE IN APPLICATION

- It is this ideal combination of wear resistance and toughness that gives **Tiger-tec® Silver** cutting tool material superior power in machining.
- The high levels of wear resistance, toughness and temperature resistance prevent fractures and wear. As a result, the insert lasts longer.

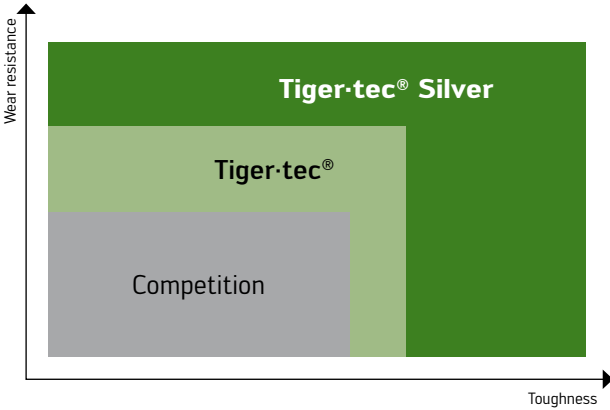

Tiger-tec® Silver

INCREASED WEAR RESISTANCE

Competitors

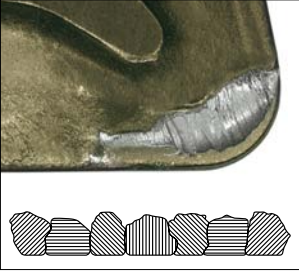

Conventional aluminium oxide – high level of crater wear due to random structural arrangement

Tiger-tec® Silver

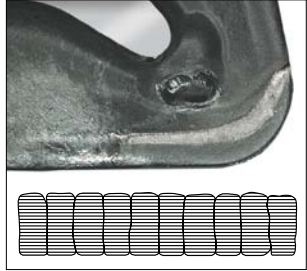

Aluminium oxide with optimised microstructure

INCREASED TOUGHNESS

Competitors

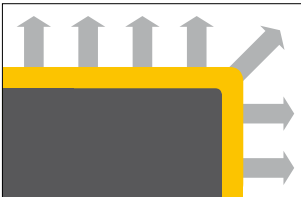
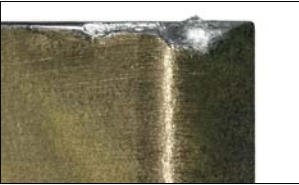

Tensile stresses/risk of fractures in the CVD coating

Tiger-tec® Silver

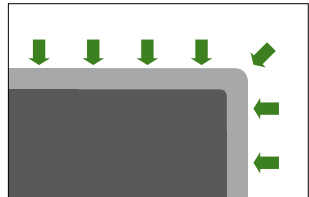
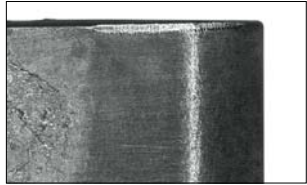

Compressive stresses in the CVD coating caused by mechanical post-treatment

Walter Tiger-tec® Silver – ISO P Generation: Geometry overview

FIELD OF APPLICATIONS FOR NEW ISO P GEOMETRIES

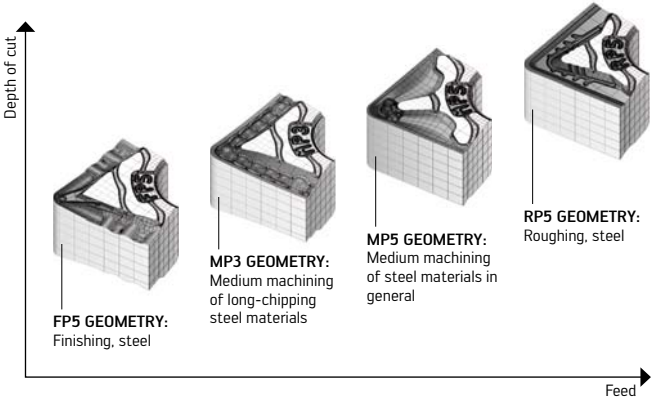

GEOMETRY OVERVIEW OF WALTER P GENERATION

In the **Tiger-tec® Silver – ISO P generation**, four geometries have been developed in parallel and matched to each other. The range of supported applications has been increased by up to 40% in comparison to previous geometries.

The result: The whole application range of cutting steel is completely covered.

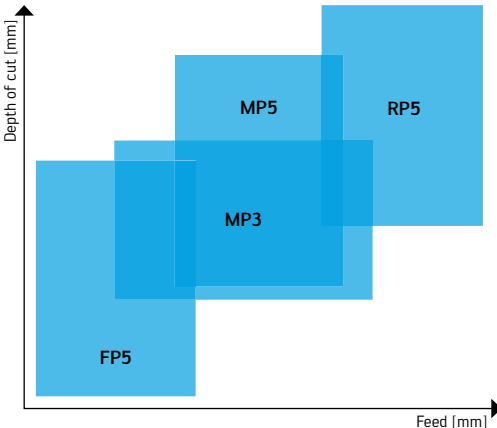

Walter Tiger-tec® Silver – ISO P Generation: Overview of cutting materials

OVERVIEW OF TIGER-TEC® SILVER CUTTING MATERIALS

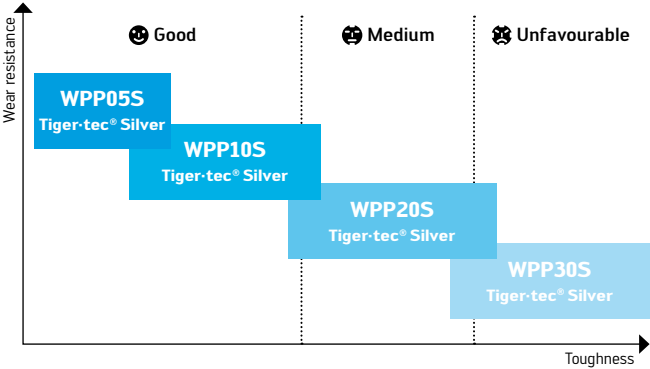

WPP05S (ISO P05)

- Maximum wear resistance under conditions of crater wear and plastic deformation
- Continuous cut
- Maximum productivity

WPP10S (ISO P10)

- Excellent wear resistance
- Continuous and light to medium interrupted cuts

WPP20S (ISO P20)

- Universal cutting material, for approx 50% of all applications
- Universal cutting material, ranging from roughing to finishing
- Adds reliability to automated production

WPP30S (ISO P30)

- Tough cutting material for interrupted cuts or unstable conditions
- Maximum machining reliability

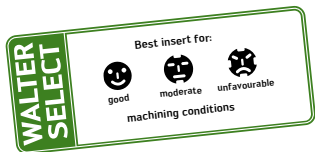

Walter Tiger-tec® Silver – ISO P Generation: Chip breaking area

NEW GEOMETRIES LARGE, UNIVERSAL CHIP BREAKING AREA

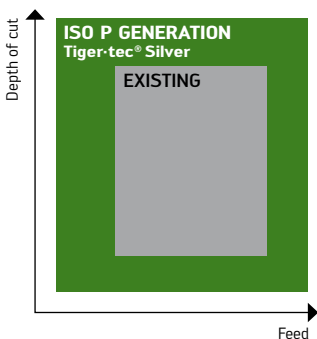

Properties of the new geometries:

- Large, universal chip breaking area
- Reduction of the number of geometries in your production
- Coordinated geometry family
- Simple geometry selection

Tiger-tec® Silver



CHIP-BREAKING TEST – LONG-CHIPPING STEEL

Workpiece material: 16MnCr5 (1.7131)

Tensile strength: 500 N/mm²

Tool: C5-PDJNL35060-15

Cutting speed: 230 m/min

**Indexable insert
from competitor:** DNMG150608-M ISO P20

**Indexable insert
from Walter:** DNMG150608-MP3 WPP20S
Tiger-tec® Silver



COMPETITOR: DNMG150608-M ISO P20

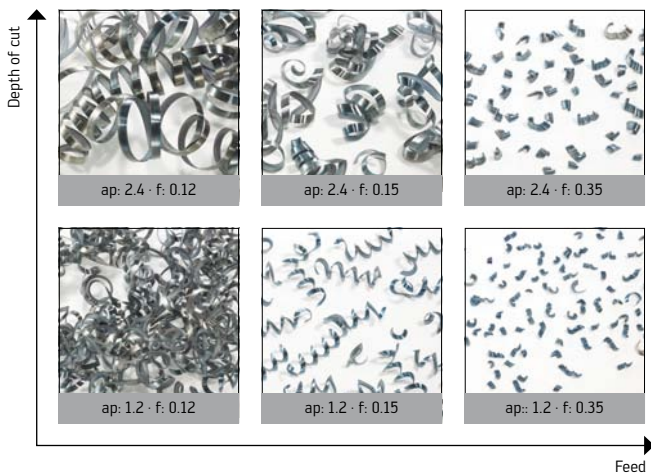

WALTER TIGER-TEC® SILVER: DNMG150608-MP3 WPP20S

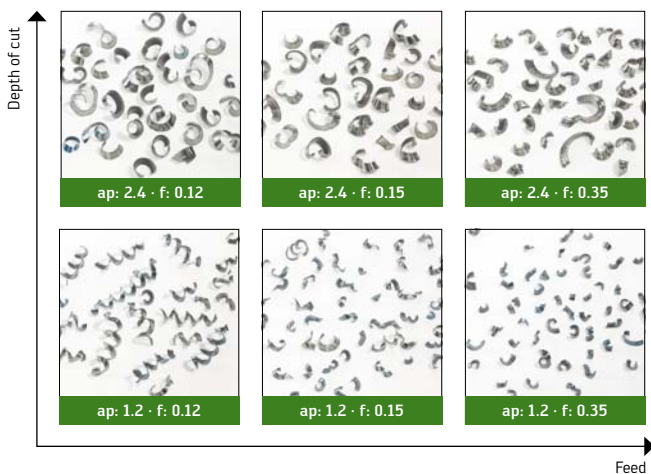

Application example – FP5

TRANSMISSION SHAFT FINISHING – WITHOUT BIRD NESTING

Workpiece material: Cf53 (1.1213)
Tensile strength: 750 N/mm²
Indexable insert: TNMG160408-FP5
Cutting tool material: WPP10S Tiger-tec® Silver
Tool: MTJNR2525M16 (93°)



Cutting data

	Competition ISO P15	Tiger-tec® Silver WPP10S
v_c	245 m/min	245 m/min
f	0.3 mm	0.3 mm
a_p	0.8 mm	0.8 mm
Tool life	450 components	700 components

Comment:

Removing chips by hand after producing 150 components is no longer necessary with the FP5 geometry.

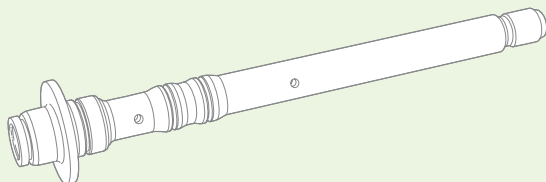

Comparison of the number of components

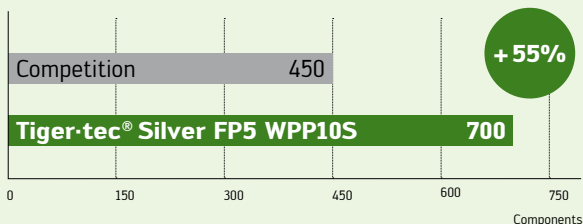

Application example – MP3

MACHINING OF FORGED BALL JOINTS

Workpiece material: 42CrMo4S4 (1.7225)
Tensile strength: 950–1050 N/mm²
Indexable insert: DNMG150612-MP3
Cutting tool material: WPP10S Tiger-tec® Silver
Tool: DDNNN2525M15 (62.5°)



Cutting data

	Competition ISO P10	Tiger-tec® WPP10	Tiger-tec® Silver WPP10S
v_c	165 m/min	165 m/min	200 m/min
f	0.2–0.38 mm	0.2–0.38 mm	0.2–0.38 mm
a_p	1.4–3.0 mm	1.4–3.0 mm	1.4–3.0 mm
Tool life	200 components	250 components	350 components

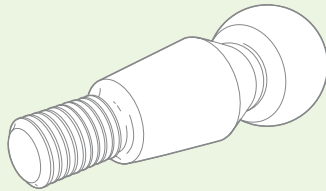

Comparison of the number of components

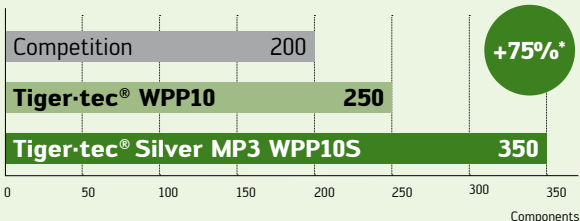

* in comparison to the competition

Application example – MP5

TURNING CAMSHAFTS – REPEATED INTERRUPTED CUTS

Workpiece material: 16MnCr5 (1.7131)
Tensile strength: 600–700 N/mm²
Indexable insert: DNMG150608-MP5
Cutting tool material: WPP30S Tiger-tec® Silver
Tool: DDJNR2525M15



Cutting data

	Competition ISO P30	Tiger-tec® Silver WPP30S
v_c	220 m/min	220 m/min
f	0.4 mm	0.4 mm
a_p	2.5 mm	2.5 mm
Tool life	55 components	110 components

Comment:

No notching on the indexable insert at the depth of cut, which therefore reduces burr formation on the component.

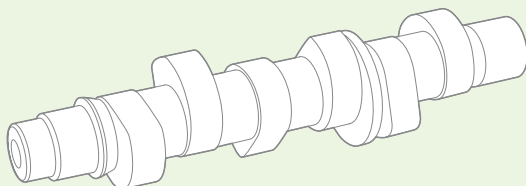

Comparison of the number of components

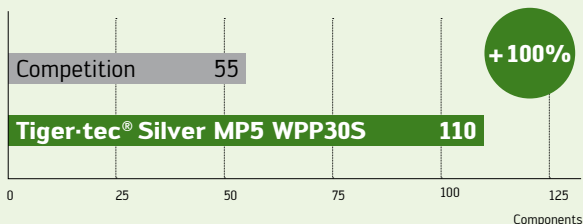

Application example – RP5

GEAR HUB ROUGHING Ø 750 mm – INTERNAL TURNING

Workpiece material: 47CrMo44 (1.2341)
Tensile strength: 950–1050 N/mm²
Indexable insert: CNMG160612-RP5
Cutting tool material: **WPP10S Tiger-tec® Silver**
Tool: PCLNL3225P16



Cutting data

	Competition ISO P15	Tiger-tec® Silver WPP10S
v_c	165 m/min	200 m/min
f	0.55 mm	0.6 mm
a_p	4-6 mm	4-6 mm
Tool life	7 components	11 components

Comment:

Customers can also use the CNMG160612-RP5 WPP10S indexable insert successfully on GGG70 components. The number of different indexable inserts in production has been reduced.

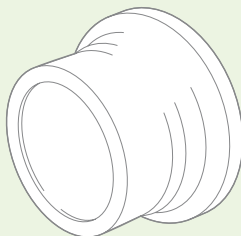

Comparison of the number of components

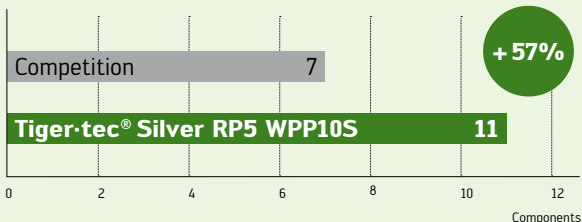

Walter Tiger-tec® Silver – ISO P Generation: Product advantages

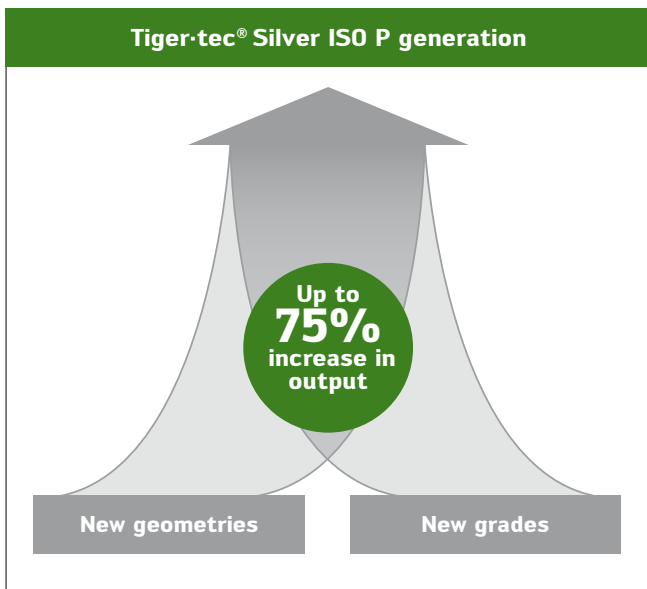

YOUR ADVANTAGES

- Higher level of productivity, higher cutting speed thanks to new aluminium oxide coating with optimised microstructure
- Longer tool life thanks to new aluminium oxide coating, microedge technology and new ISO P geometry design
- Higher level of process reliability and longer tool life thanks to new mechanical post-treatment
- Higher level of process reliability under conditions of stress because the contact surface is ground after coating
- Simple selection due to new designation key
- Problem-free chip removal thanks to large universal breaking area of the new ISO P geometries
- Reduction of the number of geometries in production because four geometries have been coordinated and developed in parallel



NEW CUTTING MATERIALS,
NEW GEOMETRIES:
MORE FORCE,
MORE PRECISION



Tiger-tec® Silver



Geometry designation key

M	P	5
1	2	3

1
Chip breaking area
<p>F Finishing</p> <p>M Medium machining</p> <p>R Roughing</p> <p>H Heavy-duty machining</p>

2		
Material		
<table style="width: 100%; border: none;"> <tr> <td style="width: 50%; vertical-align: top; padding-right: 10px;"> <p>P Steel</p> <p>M Stainless steel</p> <p>K Cast iron</p> <p>N NF metals</p> <p>S Difficult-to-cut materials</p> <p>H Hard materials</p> </td> <td style="width: 50%; vertical-align: top; border-left: 1px solid black; padding-left: 10px;"> <p>U Universal</p> <p>W Wiper</p> </td> </tr> </table>	<p>P Steel</p> <p>M Stainless steel</p> <p>K Cast iron</p> <p>N NF metals</p> <p>S Difficult-to-cut materials</p> <p>H Hard materials</p>	<p>U Universal</p> <p>W Wiper</p>
<p>P Steel</p> <p>M Stainless steel</p> <p>K Cast iron</p> <p>N NF metals</p> <p>S Difficult-to-cut materials</p> <p>H Hard materials</p>	<p>U Universal</p> <p>W Wiper</p>	

3									
Feed rate/depth of cut within chip breaking area									
<p>High</p> <table style="margin: auto; border: none;"> <tr><td style="text-align: center;">9</td></tr> <tr><td style="text-align: center;">8</td></tr> <tr><td style="text-align: center;">7</td></tr> <tr><td style="text-align: center;">6</td></tr> <tr><td style="text-align: center;">5</td></tr> <tr><td style="text-align: center;">4</td></tr> <tr><td style="text-align: center;">3</td></tr> <tr><td style="text-align: center;">2</td></tr> <tr><td style="text-align: center;">1</td></tr> </table> <p>Low</p>	9	8	7	6	5	4	3	2	1
9									
8									
7									
6									
5									
4									
3									
2									
1									

Cutting material designation key

W	P	P	20	S
Walter	1	2	3	4

1	
1st primary application or coating type	
P Steel	P CVD aluminium coating
M Stainless steel	S PVD coating
K Cast iron	
N NF metals	
S Difficult-to-cut materials	
H Hard materials	

2	
2nd primary application	
P Steel	
M Stainless steel	
K Cast iron	
N NF metals	
S Difficult-to-cut materials	
H Hard materials	

3	
ISO application range	
<p>Wear resistance</p> <p>01 05 10 20 21 23 30 32 33 43</p> <p>Toughness</p>	<p>Cutting tool materials for:</p> <p>0 ISO turning 1 ISO turning 5 ISO turning 2 Threading 3 Grooving</p>

4	
Generation	
S	Tiger-tec® Silver

Walter Select Turning

The best way to the optimum indexable insert

STEP 1

The **material** to be machined is steel.

Code letter	Machining group	Groups of the materials to be machined	
P	P1-P15	Steel	All types of steel and steel casting, with the exception of steel with an austenitic structure

STEP 2

Select the **machining conditions**:

Type of workpiece	Machine stability, clamping system and workpiece		
	Very good	Good	Moderate
Smooth cut Pre-machined			
Cast or forged skin Variable depths of cut			
Interrupted cuts			

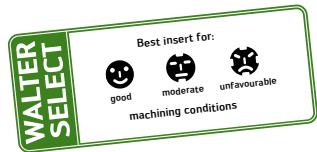

STEP 3

Determine the **basic shape** of the indexable insert:

Positive basic shape	Negative basic shape, double sided	Negative basic shape, single sided	
-	Cutting forces [F_c]		+
-	Feed [f]		+
-	Depth of cut [a_p]		+

STEP 4

Determine the **indexable insert geometry** using depth of cut (a_p) and feed rate (f).

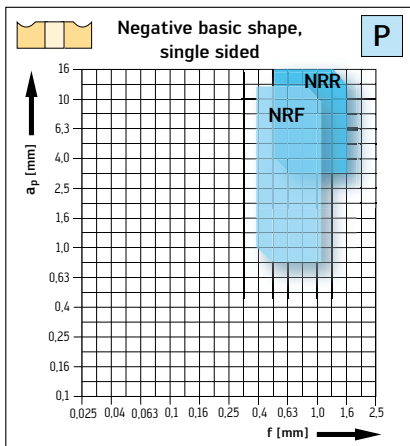
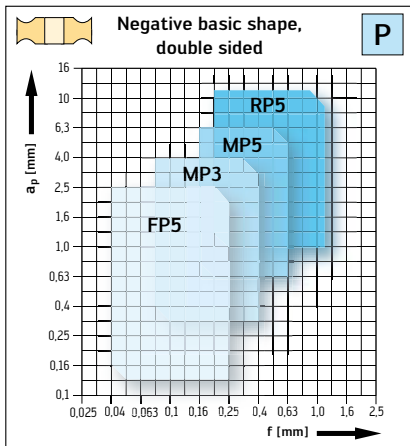

STEP 5

Select the **cutting data** – see page 32.

FP5 geometry – finishing of steel

THE APPLICATION

- V chip breaker guarantees reliable chip control during turning and facing operations from a depth of cut of 0.2 mm
- Positive, curved cutting edge for reduced tendency to oscillate and excellent surface finish quality
- Undulating chip formers prevent swarf packing in copy turning and facing operations

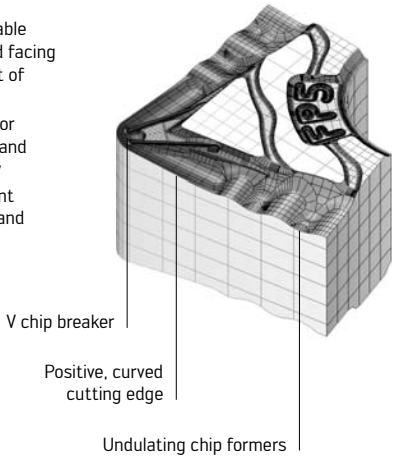



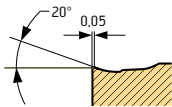

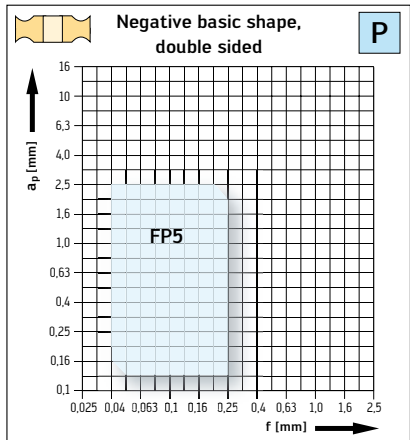
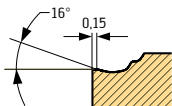

CUT RADIUS



CUT MAIN CUTTING EDGE



Indexable inserts

	Designation	f mm	a _p mm	P HC			
				WPP05S	WPP10S	WPP20S	WPP30S
	CNMG090304-FP5	0.04 - 0.20	0.1 - 1.5		☺	☺	
	CNMG090308-FP5	0.08 - 0.25	0.2 - 2.0		☺	☺	
	CNMG120404-FP5	0.04 - 0.20	0.1 - 1.5		☺	☺	
	CNMG120408-FP5	0.08 - 0.25	0.2 - 2.0		☺	☺	
	CNMG120412-FP5	0.10 - 0.25	0.5 - 2.5		☺	☺	
	DNMG110402-FP5	0.04 - 0.12	0.1 - 0.5		☺	☺	
	DNMG110404-FP5	0.04 - 0.20	0.1 - 1.5		☺	☺	
	DNMG110408-FP5	0.08 - 0.25	0.2 - 2.0		☺	☺	
	DNMG110412-FP5	0.10 - 0.25	0.5 - 2.5		☺	☺	
	DNMG150404-FP5	0.05 - 0.20	0.1 - 1.5		☺	☺	
	DNMG150408-FP5	0.08 - 0.25	0.2 - 2.0		☺	☺	
	DNMG150412-FP5	0.10 - 0.25	0.5 - 2.5		☺	☺	
	DNMG150604-FP5	0.05 - 0.20	0.1 - 1.5		☺	☺	
	DNMG150608-FP5	0.08 - 0.25	0.2 - 2.0		☺	☺	
	DNMG150612-FP5	0.10 - 0.25	0.5 - 2.5		☺	☺	
	SNMG090308-FP5	0.06 - 0.20	0.15 - 1.5		☺	☺	
	SNMG120404-FP5	0.04 - 0.22	0.1 - 1.8		☺	☺	
	SNMG120408-FP5	0.08 - 0.25	0.2 - 2.0		☺	☺	
	SNMG120412-FP5	0.10 - 0.25	0.5 - 2.5		☺	☺	
	TNMG110304-FP5	0.04 - 0.15	0.08 - 1.2		☺	☺	
	TNMG110308-FP5	0.08 - 0.20	0.15 - 1.5		☺	☺	
	TNMG160404-FP5	0.04 - 0.20	0.1 - 1.5		☺	☺	
	TNMG160408-FP5	0.08 - 0.25	0.2 - 2.0		☺	☺	
	TNMG160412-FP5	0.10 - 0.25	0.5 - 2.5		☺	☺	
	VNMG160404-FP5	0.04 - 0.22	0.1 - 1.5		☺	☺	
	VNMG160408-FP5	0.08 - 0.25	0.2 - 2.0		☺	☺	
	WNMG060404-FP5	0.04 - 0.20	0.1 - 1.5		☺	☺	
	WNMG060408-FP5	0.08 - 0.25	0.2 - 2.0		☺	☺	
	WNMG080404-FP5	0.05 - 0.20	0.1 - 1.5		☺	☺	
	WNMG080408-FP5	0.08 - 0.25	0.2 - 2.0		☺	☺	
	WNMG080412-FP5	0.10 - 0.25	0.5 - 2.5		☺	☺	

HC = Coated carbide

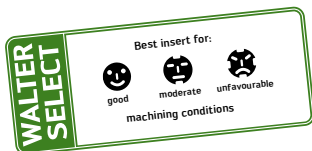

MP3 geometry – medium machining of long-chipping materials

THE APPLICATION

- Machining of forged parts close to the shape of the finished contour such as gearwheels, ball joints, transmission shaft.
- Extruded parts with thin wall thickness, e.g. cover plugs, converter housings for automatic transmissions, etc., can be machined free of burrs
- "Bullet design" gives the chip extra rigidity for optimum chip breaking

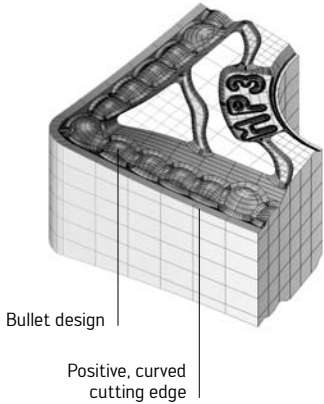



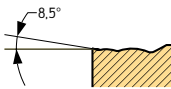

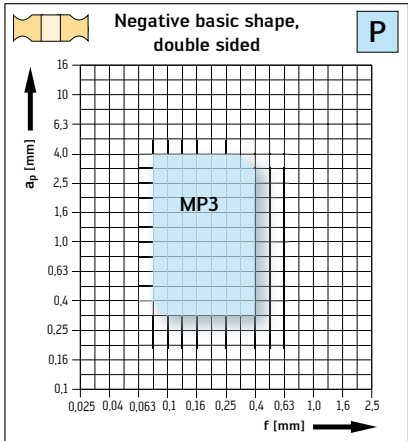
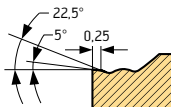

CUT RADIUS



CUT MAIN CUTTING EDGE



Indexable inserts

	Designation	f mm	a _p mm	P HC			
				WPP05S	WPP10S	WPP20S	WPP30S
	CNMG090304-MP3	0.06 - 0.20	0.3 - 2.2		☺	☺	
	CNMG090308-MP3	0.10 - 0.28	0.6 - 3.0		☺	☺	
	CNMG120404-MP3	0.08 - 0.22	0.3 - 2.5		☺	☺	☹
	CNMG120408-MP3	0.12 - 0.32	0.6 - 3.2		☺	☺	☹
	CNMG120412-MP3	0.16 - 0.40	0.8 - 3.5	☺	☺	☺	☹
	DNMG110404-MP3	0.08 - 0.22	0.3 - 2.2		☺	☺	☹
	DNMG110408-MP3	0.12 - 0.32	0.6 - 3.0	☺	☺	☺	☹
	DNMG110412-MP3	0.16 - 0.35	0.8 - 3.2	☺	☺	☺	☹
	DNMG150404-MP3	0.08 - 0.22	0.3 - 2.5		☺	☺	☹
	DNMG150408-MP3	0.12 - 0.32	0.6 - 3.2	☺	☺	☺	☹
	DNMG150412-MP3	0.16 - 0.40	0.8 - 3.5	☺	☺	☺	☹
	DNMG150604-MP3	0.08 - 0.22	0.3 - 2.5		☺	☺	☹
	DNMG150608-MP3	0.12 - 0.32	0.6 - 3.2	☺	☺	☺	☹
	DNMG150612-MP3	0.16 - 0.40	0.8 - 3.5	☺	☺	☺	☹
	SNMG090308-MP3	0.10 - 0.32	0.6 - 3.0		☺	☺	
	SNMG120404-MP3	0.08 - 0.25	0.3 - 2.5		☺	☺	
	SNMG120408-MP3	0.12 - 0.35	0.6 - 3.2		☺	☺	
	SNMG120412-MP3	0.16 - 0.40	0.8 - 3.5		☺	☺	
	TNMG110304-MP3	0.06 - 0.18	0.3 - 2.0		☺	☺	
	TNMG110308-MP3	0.10 - 0.25	0.6 - 2.2		☺	☺	
	TNMG160404-MP3	0.08 - 0.22	0.3 - 2.2		☺	☺	☹
	TNMG160408-MP3	0.12 - 0.32	0.6 - 3.0	☺	☺	☺	☹
	TNMG160412-MP3	0.16 - 0.40	0.8 - 3.2	☺	☺	☺	☹
	TNMG220408-MP3	0.12 - 0.32	0.6 - 3.2	☺	☺	☺	☹
	TNMG220412-MP3	0.16 - 0.40	0.8 - 3.5	☺	☺	☺	☹
	VNMG160404-MP3	0.08 - 0.22	0.3 - 2.2		☺	☺	☹
	VNMG160408-MP3	0.12 - 0.32	0.6 - 3.0	☺	☺	☺	☹
	VNMG160412-MP3	0.16 - 0.35	0.8 - 3.2	☺	☺	☺	☹
	WNMG060404-MP3	0.08 - 0.22	0.3 - 2.2		☺	☺	☹
	WNMG060408-MP3	0.12 - 0.32	0.6 - 3.0	☺	☺	☺	☹
	WNMG060412-MP3	0.16 - 0.35	0.8 - 3.2	☺	☺	☺	☹
	WNMG080404-MP3	0.08 - 0.22	0.3 - 2.5		☺	☺	☹
	WNMG080408-MP3	0.12 - 0.32	0.6 - 3.2	☺	☺	☺	☹
	WNMG080412-MP3	0.16 - 0.40	0.8 - 3.5	☺	☺	☺	☹

HC = Coated carbide

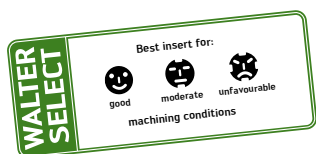

MP5 geometry – general medium machining of steel materials

THE APPLICATION

- Universal application – from smooth cut on bar material through to interrupted cuts
- The solution for a wide diversity of components in production
- Reinforced chip breaker blades for improved chip breaking and reduced rate of wear

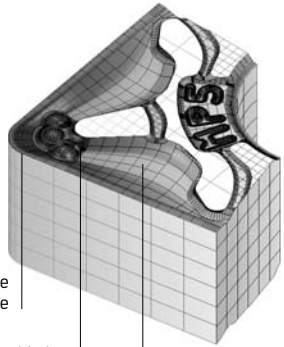

Universal, stable three-centre curve cutting edge

Reinforced chip breaker blades in the radius range

Open groove on the main cutting edge



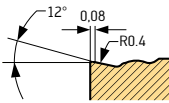

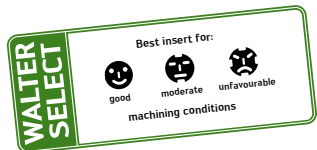
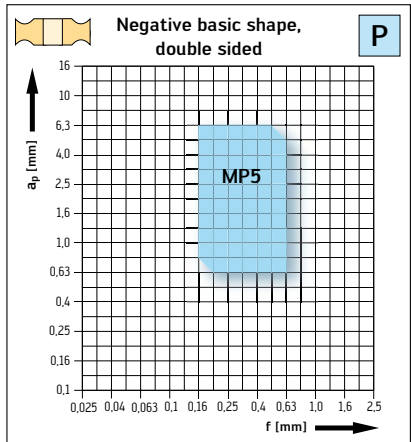
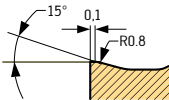

CUT RADIUS



CUT MAIN CUTTING EDGE



Indexable inserts

	Designation	f mm	ap mm	P				
				WPP05S	WPP10S	WPP20S	WPP30S	
	CNMG120404-MP5	0.16 - 0.25	0.5 - 4.0		☺	☺	☺	
	CNMG120408-MP5	0.18 - 0.40	0.6 - 5.0	☺	☺	☺	☺	
	CNMG120412-MP5	0.20 - 0.45	1.0 - 5.0	☺	☺	☺	☺	
	CNMG120416-MP5	0.25 - 0.50	1.2 - 5.0	☺	☺	☺	☺	
	CNMG160608-MP5	0.25 - 0.50	0.8 - 7.0	☺	☺	☺	☺	
	CNMG160612-MP5	0.30 - 0.50	1.0 - 7.0	☺	☺	☺	☺	
	CNMG160616-MP5	0.35 - 0.55	1.2 - 7.0		☺	☺	☺	
	DNMG110404-MP5	0.16 - 0.25	0.5 - 4.0		☺	☺	☺	
	DNMG110408-MP5	0.18 - 0.35	0.6 - 4.0	☺	☺	☺	☺	
	DNMG110412-MP5	0.20 - 0.40	1.0 - 4.0	☺	☺	☺	☺	
	DNMG150404-MP5	0.16 - 0.25	0.5 - 4.0		☺	☺	☺	
	DNMG150408-MP5	0.18 - 0.35	0.6 - 5.0	☺	☺	☺	☺	
	DNMG150412-MP5	0.20 - 0.40	1.0 - 5.0	☺	☺	☺	☺	
	DNMG150416-MP5	0.25 - 0.45	1.2 - 5.0		☺	☺	☺	
	DNMG150604-MP5	0.16 - 0.25	0.5 - 4.0		☺	☺	☺	
	DNMG150608-MP5	0.18 - 0.35	0.6 - 5.0	☺	☺	☺	☺	
	DNMG150612-MP5	0.20 - 0.40	1.0 - 5.0	☺	☺	☺	☺	
	DNMG150616-MP5	0.25 - 0.45	1.2 - 5.0		☺	☺	☺	
		SNMG120408-MP5	0.18 - 0.40	0.6 - 5.0	☺	☺	☺	☺
		SNMG120412-MP5	0.20 - 0.45	1.0 - 5.0	☺	☺	☺	☺
SNMG120416-MP5		0.25 - 0.50	1.2 - 5.0	☺	☺	☺	☺	
SNMG150608-MP5		0.25 - 0.50	0.8 - 8.0	☺	☺	☺	☺	
SNMG150612-MP5		0.30 - 0.50	1.0 - 8.0	☺	☺	☺	☺	
SNMG150616-MP5		0.35 - 0.55	1.2 - 8.0		☺	☺	☺	
	TNMG160404-MP5	0.16 - 0.25	0.5 - 4.0		☺	☺	☺	
	TNMG160408-MP5	0.18 - 0.35	0.6 - 4.0	☺	☺	☺	☺	
	TNMG160412-MP5	0.20 - 0.40	1.0 - 4.0	☺	☺	☺	☺	
	TNMG220408-MP5	0.18 - 0.35	0.8 - 5.0	☺	☺	☺	☺	
	TNMG220412-MP5	0.20 - 0.40	1.0 - 5.0	☺	☺	☺	☺	
	TNMG270608-MP5	0.25 - 0.45	0.8 - 7.0		☺	☺	☺	
	TNMG270612-MP5	0.30 - 0.50	1.0 - 7.0		☺	☺	☺	
	TNMG270616-MP5	0.35 - 0.55	1.2 - 7.0		☺	☺	☺	
		VNMG160404-MP5	0.16 - 0.25	0.5 - 4.0		☺	☺	☺
VNMG160408-MP5		0.18 - 0.35	0.6 - 4.0	☺	☺	☺	☺	
VNMG160412-MP5		0.20 - 0.40	1.0 - 4.0	☺	☺	☺	☺	
	WNMG060404-MP5	0.16 - 0.25	0.5 - 4.0		☺	☺	☺	
	WNMG060408-MP5	0.18 - 0.35	0.6 - 4.0	☺	☺	☺	☺	
	WNMG060412-MP5	0.20 - 0.40	1.0 - 4.0	☺	☺	☺	☺	
	WNMG080404-MP5	0.16 - 0.25	0.5 - 4.0		☺	☺	☺	
	WNMG080408-MP5	0.18 - 0.40	0.6 - 5.0	☺	☺	☺	☺	
	WNMG080412-MP5	0.20 - 0.45	1.0 - 5.0	☺	☺	☺	☺	
	WNMG080416-MP5	0.25 - 0.50	1.2 - 5.0	☺	☺	☺	☺	
	WNMG100608-MP5	0.25 - 0.40	0.8 - 7.0		☺	☺	☺	
	WNMG100612-MP5	0.30 - 0.50	1.0 - 7.0	☺	☺	☺	☺	
	WNMG100616-MP5	0.35 - 0.55	1.2 - 7.0		☺	☺	☺	

RP5 geometry – roughing of steel

THE APPLICATION

- The stable, positive 3° chamfer for roughing with low power requirement
- Open groove design produces low cutting temperature and reduces wear in comparison with previous geometries
- Wider chamfer in the centre region of the depth of cut prevents notching when machining skins

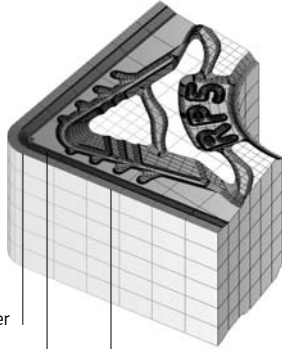

Stable, positive 3° chamfer

Open, deep and wide chip breaker groove

Wider chamfer in the centre region of the main cutting edge



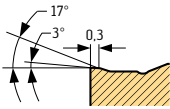

CUT RADIUS

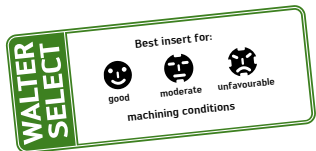
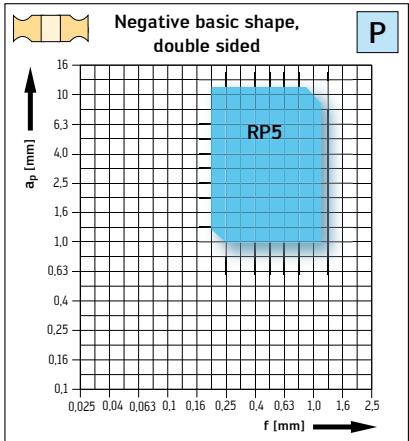
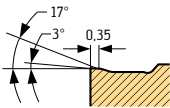

CUT MAIN CUTTING EDGE



Indexable inserts

	Designation	f mm	a _p mm	P HC			
				WPP05S	WPP10S	WPP20S	WPP30S
	CNMG120408-RP5	0.20 - 0.40	1.0 - 6.0	☺	☺	☺	☹
	CNMG120412-RP5	0.25 - 0.60	1.0 - 6.0	☺	☺	☺	☹
	CNMG120416-RP5	0.35 - 0.70	1.0 - 6.0	☺	☺	☺	☹
	CNMG160608-RP5	0.20 - 0.45	2.0 - 8.0	☺	☺	☺	☹
	CNMG160612-RP5	0.25 - 0.60	2.0 - 8.0	☺	☺	☺	☹
	CNMG160616-RP5	0.35 - 0.70	2.0 - 8.0	☺	☺	☺	☹
	CNMG190608-RP5	0.20 - 0.50	2.0 - 10.0	☺	☺	☺	☹
	CNMG190612-RP5	0.25 - 0.65	2.0 - 10.0	☺	☺	☺	☹
	CNMG190616-RP5	0.35 - 0.80	2.0 - 10.0	☺	☺	☺	☹
	CNMG190624-RP5	0.45 - 1.00	2.0 - 10.0		☺	☺	☹
CNMG250924-RP5	0.45 - 1.20	2.0 - 12.0		☺	☺	☹	
	DNMG110408-RP5	0.18 - 0.35	1.0 - 4.0	☺	☺	☺	☹
	DNMG110412-RP5	0.20 - 0.40	1.0 - 4.0	☺	☺	☺	☹
	DNMG150408-RP5	0.15 - 0.35	1.0 - 6.0	☺	☺	☺	☹
	DNMG150412-RP5	0.20 - 0.40	1.0 - 6.0	☺	☺	☺	☹
	DNMG150416-RP5	0.25 - 0.50	1.0 - 6.0	☺	☺	☺	☹
	DNMG150608-RP5	0.15 - 0.35	1.0 - 6.0	☺	☺	☺	☹
	DNMG150612-RP5	0.20 - 0.55	1.0 - 6.0	☺	☺	☺	☹
	DNMG150616-RP5	0.25 - 0.65	1.0 - 6.0	☺	☺	☺	☹
	SNMG120408-RP5	0.20 - 0.50	1.0 - 6.0	☺	☺	☺	☹
	SNMG120412-RP5	0.25 - 0.65	1.0 - 6.0	☺	☺	☺	☹
	SNMG120416-RP5	0.35 - 0.75	1.0 - 6.0	☺	☺	☺	☹
	SNMG150612-RP5	0.25 - 0.70	2.0 - 8.0	☺	☺	☺	☹
	SNMG150616-RP5	0.35 - 0.80	2.0 - 8.0	☺	☺	☺	☹
	SNMG190612-RP5	0.30 - 0.70	2.0 - 10.0	☺	☺	☺	☹
	SNMG190616-RP5	0.35 - 0.90	2.0 - 10.0	☺	☺	☺	☹
	SNMG190624-RP5	0.45 - 1.20	2.0 - 10.0		☺	☺	☹
	SNMG250924-RP5	0.55 - 1.20	2.5 - 12.0		☺	☺	☹
	TNMG160408-RP5	0.20 - 0.40	1.0 - 5.0	☺	☺	☺	☹
	TNMG160412-RP5	0.25 - 0.55	1.0 - 5.0	☺	☺	☺	☹
	TNMG220408-RP5	0.20 - 0.45	2.0 - 7.0	☺	☺	☺	☹
	TNMG220412-RP5	0.25 - 0.60	2.0 - 7.0	☺	☺	☺	☹
	TNMG220416-RP5	0.35 - 0.70	2.0 - 7.0	☺	☺	☺	☹
	TNMG270612-RP5	0.35 - 0.70	2.5 - 10.0		☺	☺	☹
	TNMG270616-RP5	0.35 - 0.75	2.5 - 10.0		☺	☺	☹
	TNMG330924-RP5	0.45 - 0.90	3.0 - 13.0		☺	☺	☹
		WNMG060408-RP5	0.20 - 0.40	0.8 - 4.0	☺	☺	☺
WNMG060412-RP5		0.25 - 0.50	0.8 - 4.0	☺	☺	☺	☹
WNMG080408-RP5		0.20 - 0.40	1.0 - 6.0	☺	☺	☺	☹
WNMG080412-RP5		0.25 - 0.60	1.0 - 6.0	☺	☺	☺	☹
WNMG080416-RP5		0.35 - 0.70	1.0 - 6.0	☺	☺	☺	☹
WNMG100612-RP5		0.25 - 0.60	2.0 - 8.0	☺	☺	☺	☹
WNMG100616-RP5		0.35 - 0.70	2.0 - 8.0	☺	☺	☺	☹

HC = Coated carbide

NRF geometry – universal roughing insert

THE APPLICATION

- Universal, single sided indexable insert thanks to two geometries in one insert
- V chip former (cutting edge radius) perfect chip breaking even for small depths of cut or large fluctuations in material removal
- Reinforced, curved double groove (main cutting edge) for large depths of cut and accelerated feed rates



V chip former on the cutting edge radius

Reinforced double groove on the main cutting edge

Curved cutting edge



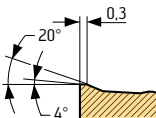

CUT RADIUS

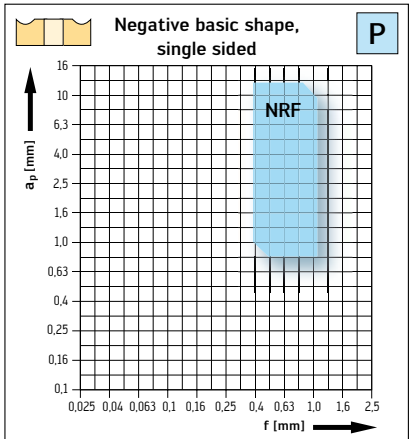
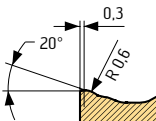

CUT MAIN CUTTING EDGE



Indexable inserts

	Designation	f mm	a _p mm	P HC			
				WPP05S	WPP10S	WPP20S	WPP30S
	CNMM120408-NRF	0.30 - 0.50	0.8 - 7.0		☺	☺	☹
	CNMM120412-NRF	0.35 - 0.70	1.2 - 7.0	☺	☺	☺	☹
	CNMM120416-NRF	0.40 - 0.80	1.6 - 7.0	☺	☺	☺	☹
	CNMM160612-NRF	0.35 - 0.70	1.2 - 9.0		☺	☺	☹
	CNMM160616-NRF	0.40 - 0.90	1.6 - 9.0	☺	☺	☺	☹
	CNMM160624-NRF	0.45 - 1.00	2.4 - 9.0		☺	☺	☹
	CNMM190612-NRF	0.35 - 0.70	1.2 - 10.0	☺	☺	☺	☹
	CNMM190616-NRF	0.40 - 0.90	1.6 - 10.0	☺	☺	☺	☹
	CNMM190624-NRF	0.45 - 1.10	2.4 - 10.0		☺	☺	☹
	CNMM250924-NRF	0.45 - 1.20	2.4 - 12.0			☺	☹
	DNMM150608-NRF	0.25 - 0.45	0.8 - 5.0	☺	☺	☺	☹
	DNMM150612-NRF	0.30 - 0.50	1.2 - 5.0	☺	☺	☺	☹
	DNMM150616-NRF	0.35 - 0.60	1.6 - 5.0	☺	☺	☺	☹
	SNMM120408-NRF	0.30 - 0.50	0.8 - 7.0			☺	☹
	SNMM120412-NRF	0.35 - 0.70	1.2 - 7.0		☺	☺	☹
	SNMM120416-NRF	0.40 - 0.90	1.6 - 7.0		☺	☺	☹
	SNMM150612-NRF	0.35 - 0.75	1.2 - 9.0		☺	☺	☹
	SNMM150616-NRF	0.40 - 0.90	1.6 - 9.0	☺	☺	☺	☹
	SNMM150624-NRF	0.45 - 1.10	2.0 - 9.0		☺	☺	☹
	SNMM190612-NRF	0.35 - 0.75	1.2 - 10.0	☺	☺	☺	☹
	SNMM190616-NRF	0.40 - 1.00	1.6 - 10.0	☺	☺	☺	☹
	SNMM190624-NRF	0.45 - 1.20	2.0 - 10.0	☺	☺	☺	☹
	SNMM250716-NRF	0.45 - 1.00	1.6 - 12.0			☺	☹
	SNMM250724-NRF	0.55 - 1.20	2.5 - 12.0			☺	☹
	SNMM250916-NRF	0.45 - 1.00	1.6 - 12.0		☺	☺	☹
	SNMM250924-NRF	0.55 - 1.20	2.5 - 12.0			☺	☹
	TNMM160408-NRF	0.30 - 0.45	0.8 - 6.0		☺	☺	☹
	TNMM160412-NRF	0.35 - 0.50	1.2 - 6.0		☺	☺	☹
	TNMM220408-NRF	0.30 - 0.50	0.8 - 7.0		☺	☺	☹
	TNMM220412-NRF	0.35 - 0.60	1.2 - 7.0	☺	☺	☺	☹
	TNMM220416-NRF	0.40 - 0.80	1.6 - 7.0	☺	☺	☺	☹
	TNMM270612-NRF	0.35 - 0.65	1.2 - 8.0			☺	☹
	TNMM270616-NRF	0.40 - 0.85	1.6 - 8.0			☺	☹
	WNMM080412-NRF	0.35 - 0.70	1.2 - 6.0		☺	☺	☹
	WNMM100612-NRF	0.35 - 0.70	1.2 - 8.0		☺	☺	☹
	WNMM100616-NRF	0.40 - 0.90	1.6 - 8.0		☺	☺	☹

HC = Coated carbide

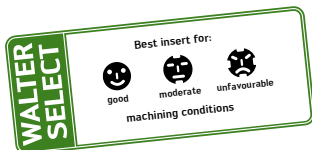

NRR geometry – heavy-duty roughing cutting

THE APPLICATION

- Single sided indexable insert for maximum feed rates and depths of cut
- Stable cutting edge design with protective chamfer and straight cutting edge for maximum stability even when machining cast or forged steels

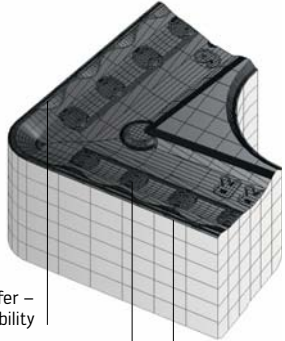

Negative protective chamfer – for stability

Chip guide – reduces friction

Straight cutting edge design – maximum insert thickness

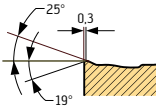

CUT RADIUS

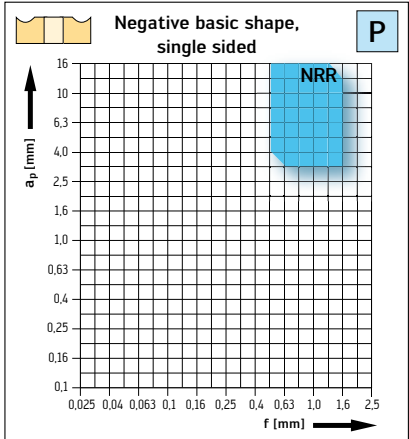
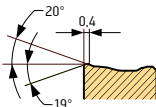

CUT MAIN CUTTING EDGE





Indexable inserts

	Designation	f mm	a _p mm	P HC				
				WPP05S	WPP10S	WPP20S	WPP30S	WAK30
	CNMM160612-NRR	0.50 - 0.90	2.0 - 10.0		☉	☉	☉	☉
	CNMM160616-NRR	0.50 - 1.10	2.0 - 10.0		☉	☉	☉	☉
	CNMM160624-NRR	0.50 - 1.30	2.0 - 10.0		☉	☉	☉	☉
	CNMM190612-NRR	0.50 - 0.90	2.0 - 13.0		☉	☉	☉	☉
	CNMM190616-NRR	0.50 - 1.10	2.0 - 13.0		☉	☉	☉	☉
	CNMM190624-NRR	0.60 - 1.60	3.0 - 13.0		☉	☉	☉	☉
	CNMM250924-NRR	0.60 - 1.60	3.0 - 17.0		☉	☉	☉	☉
	SNMM150612-NRR	0.50 - 0.80	1.5 - 10.0			☉	☉	☉
	SNMM150616-NRR	0.45 - 1.00	2.0 - 12.0		☉	☉	☉	☉
	SNMM150624-NRR	0.50 - 1.40	2.5 - 12.0			☉	☉	☉
	SNMM190612-NRR	0.50 - 1.00	2.0 - 13.0		☉	☉	☉	☉
	SNMM190616-NRR	0.50 - 1.10	2.5 - 13.0		☉	☉	☉	☉
	SNMM190624-NRR	0.60 - 1.60	3.0 - 13.0		☉	☉	☉	☉
	SNMM250716-NRR	0.50 - 1.10	2.5 - 17.0		☉	☉	☉	☉
	SNMM250724-NRR	0.60 - 1.60	3.0 - 17.0		☉	☉	☉	☉
	SNMM250732-NRR	0.60 - 1.80	4.0 - 17.0			☉	☉	
	SNMM250916-NRR	0.50 - 1.10	2.5 - 17.0		☉	☉	☉	☉
	SNMM250924-NRR	0.60 - 1.60	3.0 - 17.0		☉	☉	☉	☉
	SNMM250932-NRR	0.60 - 1.80	4.0 - 17.0			☉	☉	☉
		TNMM270616-NRR	0.50 - 1.10	2.0 - 13.0			☉	☉
TNMM270624-NRR		0.60 - 1.60	3.0 - 13.0			☉	☉	☉

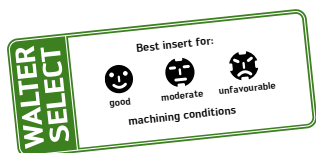

HC = Coated carbide
WAK30 = ISO P40

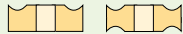

Turning insert cutting data – negative basic shape

Material group	 = Cutting data for wet machining  = Dry machining is possible		Structure of main material groups and identification letters				Brinell hardness HB	Tensile strength N/mm ²	Tensile strength (rounded up) N/mm ²
P	Unalloyed steel	C ≤ 0.25%	Annealed	125	430	430			
		C > 0.25... ≤ 0.55%	Annealed	190	639	640			
		C > 0.25... ≤ 0.55%	Heat-treated	210	708	710			
		C > 0.55%	Annealed	190	639	640			
		C > 0.55%	Heat-treated	300	1013	1020			
		Free cutting steel (short-chipping)	Annealed	220	745	750			
	Low-alloyed steel	Annealed		175	591	600			
		Heat-treated		300	1013	1020			
		Heat-treated		380	1282	1290			
		Heat-treated		430	1477	1480			
	High-alloyed steel and high-alloyed tool steel	Annealed		200	675	680			
		Hardened and tempered		300	1013	1020			
		Hardened and tempered		400	1361	1370			
	Stainless steel	Ferritic/martensitic	Annealed	200	675	680			
		Martensitic, heat-treated		330	1114	1120			
K	Malleable cast iron	Ferritic		200	675	680			
		Pearlitic		260	867	870			
	Grey cast iron	Low tensile strength		180	602	610			
		High tensile strength/austenitic		245	825	830			
	Grey cast iron with spheroidal graphite	Ferritic		155	518	520			
		Pearlitic		265	885	890			
	Cast iron with vermicular graphite			200	675	680			



Machining group			Cutting speed v_c [m/min]											
			WPP05S			WPP10S			WPP20S			WPP30S		
			f [mm/rev]			f [mm/rev]			f [mm/rev]			f [mm/rev]		
			0.10	0.40	0.60	0.10	0.40	0.60	0.10	0.40	0.60	0.10	0.40	0.60
P1	●●	●	630	490	360	620	470	360	520	380	310	440	300	250
P2	●●	●	540	400	310	530	380	300	440	310	240	370	250	200
P3	●●	●	420	320	270	400	320	260	330	260	210	270	220	160
P4	●●	●	520	370	290	500	360	280	420	290	220	350	230	180
P5	●●	●	320	250	230	320	240	220	260	190	170	210	140	110
P6	●●	●	520	370	290	500	360	280	420	290	220	350	230	180
P7	●●	●	480	340	300	460	340	290	380	280	230	310	220	200
P8	●●	●	300	240	210	290	230	200	240	170	150	190	120	90
P9	●●	●	270	190	150	250	180	140	210	150	110	150	100	70
P10	●●	●	70	60	--	60	50							
P11	●●	●	500	310	230	480	340	220	400	280	170	310	220	120
P12	●●	●	260	150	110	240	140	120	190	120	90	120	90	70
P13	●●	●	80	70	--	70	60							
P14	●●	●				380	300	260	310	250	200	240	200	150
P15	●●	●				280	200	160	220	150	110	160	110	100
K1	●●	●				320	210	160	280	220	160			
K2	●●	●				270	170	120	240	180	110			
K3	●●	●				580	340	240	510	260	190			
K4	●●	●				320	220	150	240	180	110			
K5	●●	●				340	240	180	260	190	140			
K6	●●	●				240	180	150	190	140	110			
K7	●●	●	400	260	--	290	190	160						

- Recommended application
(the specified cutting data is regarded as starting values for the recommended application)
- Possible application

Note:

If dry machining is possible, tool life is reduced on average by 20–30%.

The classification of the machining groups can be found in the 2012 Walter complete catalogue from page H 8 onwards.

Cutting tool material application charts

Tiger-tec® Silver cutting material for turning

Walter grade designation	Standard designation	Workpiece material group						
		P Steel	M Stainless steel	K Cast iron	N NF metals	S Materials with difficult cutting properties	H Hard materials	O Other
WPP05S	HC – P05	●●						
WPP10S	HC – P10	●●						
	HC – K20			●				
WPP20S	HC – P20	●●						
	HC – K30			●				
WPP30S	HC – P30	●●						



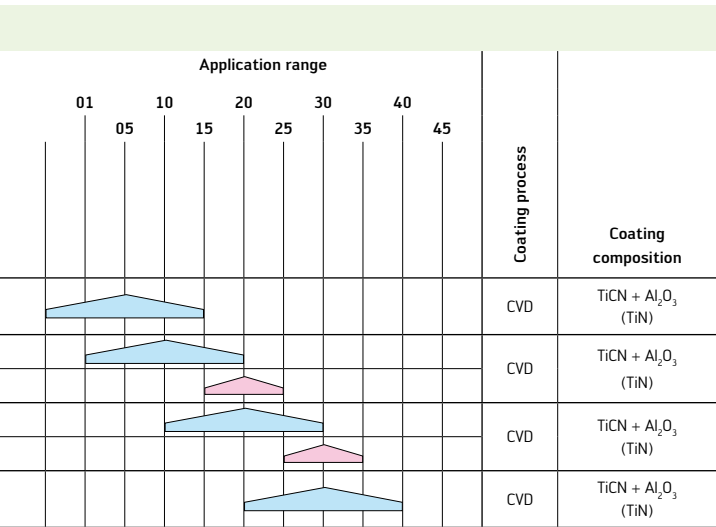

HC = Coated carbide

- Primary application
- Other application



Geometry overview of turning inserts – negative basic shape



Finishing

Geometry	Remarks/field of applications	Workpiece material group					
		P	M	K	N	S	H
 <p>Wiper</p>	<p>NF</p> <ul style="list-style-type: none"> – Finishing with wiper technology – High surface quality – High feed rates 	●●	●●	●●		●	
	<p>FP5</p> <ul style="list-style-type: none"> – Finishing of steel materials – Can also be used in semi-finishing as an alternative to the MP3 – Curved cutting edge for low cutting forces 	●●					
	<p>NFT</p> <ul style="list-style-type: none"> – Finishing of titanium materials – Sharp cutting edge with circumference fully ground, first choice – 100° corner with roughing geometry integrated within CNMG basic shape 		●		●	●●	
	<p>NF4</p> <ul style="list-style-type: none"> – Finishing of stainless materials – Finishing on difficult-to-cut alloys – Finishing long-chipping steel materials – Curved cutting edge for reduction in cutting force 	●	●●			●●	

- Primary application
- Other application

For ordering information, see the 2012 Walter complete catalogue.

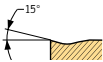
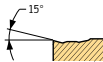
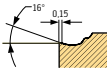
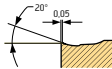
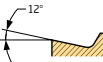

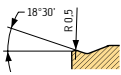
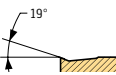



Cut Main cutting edge	Cut Corner radius	a_p [mm]	f [mm]
		0.4–3.0	0.10–0.55
		0.1–2.5	0.04–0.25
		0.1–2.0	0.05–0.20
		0.2–1.6	0.05–0.20

Comment: Cutting patterns show CNMG 120408 . .

Geometry overview of turning inserts – negative basic shape

Medium machining

Geometry	Remarks/field of applications	Workpiece material group					
		P	M	K	N	S	H
		Steel	Stainless steel	Cast iron	NF metals	Materials with difficult cutting properties	Hard materials
 Wiper	NM – Medium machining with wiper technology – High surface quality – High feed rates	●●	●	●●		●	
	MP3 – Medium machining of long-chipping steel materials – Low cutting forces due to curved cutting edge – Machining of forged parts with low material removal	●●					
	NMT – Medium machining of titanium materials – Low cutting forces		●			●●	
	NMS – Medium machining especially for high temperature alloys (Ni, Co, Fe-based alloys) – Precise cutting edge design – Alternative to NM4 stainless geometry		●			●●	
	NM4 Stainless – Universal geometry, stainless materials – Universal geometry, high temperature alloys – Machining long-chipping steel	●	●●			●●	

- Primary application
- Other application

For ordering information, see the 2012 Walter complete catalogue.



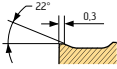
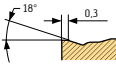
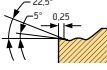
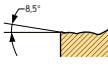
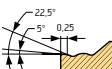
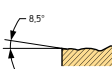
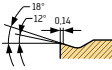
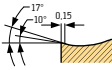
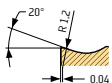
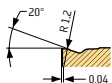

Cut Main cutting edge	Cut Corner radius	a_p [mm]	f [mm]
		0.8–4.0	0.15–0.70
		0.3–4.0	0.06–0.40
		0.6–4.0	0.12–0.32
		0.5–4.0	0.10–0.40
		0.5–4.5	0.10–0.40

Comment: Cutting patterns show CNMG 120408 . .

Geometry overview of turning inserts – negative basic shape

Medium machining – continued

Geometry	Remarks/field of applications	Workpiece material group					
		P	M	K	N	S	H
		Steel	Stainless steel	Cast iron	NF metals	Materials with difficult cutting properties	Hard materials
	MP5 – Universal geometry, steel materials – Reinforced chip breaker blades – Wide range of applications	●●					
	NM5 – Universal geometry, cast iron workpieces – Machining of steel materials with high tensile strength	●		●●			
	NM6 – Interrupted cuts – Cast and forged skins – Stable cutting edge	●●		●●			

- Primary application
- Other application

For ordering information, see the 2012 Walter complete catalogue.



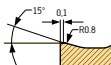
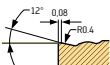
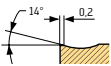
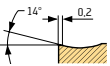
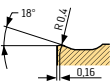
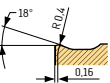





	Cut Main cutting edge	Cut Corner radius	a_p [mm]	f [mm]
			0.5–8.0	0.16–0.55
			0.6–8.0	0.15–0.90
			0.8–8.0	0.16–0.70

Comment: Cutting patterns show CNMG 120408 . .

Geometry overview of turning inserts – negative basic shape

Roughing – double sided inserts

Geometry	Remarks/field of applications	Workpiece material group					
		P	M	K	N	S	H
		Steel	Stainless steel	Cast iron	NF metals	Materials with difficult cutting properties	Hard materials
	NRT – Roughing of titanium materials – Stable cutting edge with protective chamfer					●●	
	NRS – Roughing especially for high temperature alloys (Ni, Co, Fe-based alloys) – Precise cutting edge design – Alternative to NR4 geometry		●			●●	
	NR4 – Roughing of stainless materials – Roughing of high temperature alloys		●●			●●	
	RP5 – Roughing of steel materials – Stable, positive cutting edge – Open groove for a low cutting temperature	●●		●			
	NMA – Universal geometry, cast iron workpieces			●●			
	T02020 – Cast iron machining with hard skin – Interrupted cuts – Hard machining of steel materials			●●			

- Primary application
- Other application

For ordering information, see the 2012 Walter complete catalogue.



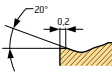
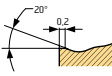
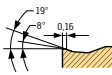
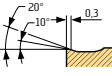
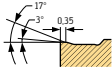
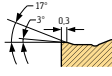
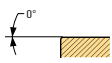
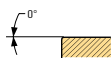
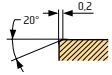
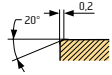

Cut Main cutting edge	Cut Corner radius	a_p [mm]	f [mm]
		0.8–9.0	0.18–0.80
		1.0–6.0	0.15–0.70
		1.2–8.5	0.22–0.80
		0.8–12.0	0.2–1.2
		0.6–8.0	0.16–0.80
		0.8–8.0	0.25–0.80

Comment: Cutting patterns show CNMG 120408 . .
or CNMA 120408 . .

Geometry overview of turning inserts – negative basic shape



Roughing – single sided inserts

Geometry	Remarks/field of applications	Workpiece material group					
		P	M	K	N	S	H
		Steel	Stainless steel	Cast iron	NF metals	Materials with difficult cutting properties	Hard materials
 <p>NRF</p> <ul style="list-style-type: none"> – Universal, single sided roughing insert – Forged parts with uneven material removal – Low power consumption – Easy-cutting geometry 	<ul style="list-style-type: none"> ●● ● ● 						
 <p>NR6</p> <ul style="list-style-type: none"> – Single sided roughing geometry – Alternative to NRF geometry – Advantage in case of crater wear 	<ul style="list-style-type: none"> ●● 						
 <p>NRR</p> <ul style="list-style-type: none"> – Heavy roughing – For machining cast skins/forged parts with negative protective chamfer – Interrupted cuts – Maximum depths of cut and feeds 	<ul style="list-style-type: none"> ●● ● 						

- Primary application
- Other application

For ordering information, see the 2012 Walter complete catalogue.

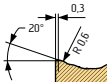
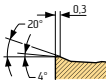
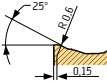

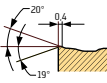
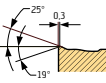



Cut Main cutting edge	Cut Corner radius	a_p [mm]	f [mm]
		0.8–12.0	0.25–1.20
		1.5–12.0	0.35–1.40
		2.0–17.0	0.50–1.80

Comment: Cutting patterns show CNMG 190616 . .

Geometry overview of turning inserts – positive basic shape



Finishing

Geometry	Remarks/field of applications	Workpiece material group					
		P	M	K	N	S	H
		Steel	Stainless steel	Cast iron	NF metals	Materials with difficult cutting properties	Hard materials
 <p>Wiper</p>	<p>PF</p> <ul style="list-style-type: none"> – Finishing with wiper technology – High surface quality – High feed rates 	●●	●●	●●		●	
	<p>PF2</p> <ul style="list-style-type: none"> – Finishing insert with fully ground circumference – Long, thin shafts with vibration tendency – Low cutting forces 	●●	●●	●	●●	●●	
	<p>PF4</p> <ul style="list-style-type: none"> – Finishing insert – Outstanding chip control – Can also be used for precision boring 	●●	●●	●		●●	
	<p>PF5</p> <ul style="list-style-type: none"> – Finishing insert with fully ground circumference – Can also be used for precision boring – Extremely narrow chip breaker groove 	●●	●●			●	
	<p>PS5 – Semifinishing</p> <ul style="list-style-type: none"> – Universal insert for operations from finishing to medium machining – Can also be used for counterboring 	●●	●●	●●		●	

- Primary application
- Other application

For ordering information, see the 2012 Walter complete catalogue.

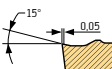
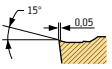
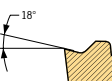
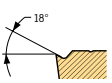
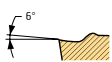
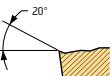
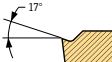

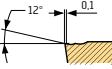
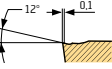

Cut Main cutting edge	Cut Corner radius	a_p [mm]	f [mm]
		0.30–3.0	0.12–0.60
		0.12–4.5	0.02–0.45
		0.1–5.0	0.04–0.40
		0.1–4.0	0.04–0.35
		0.3–2.5	0.08–0.32



Comment: Cutting patterns show CCMT 09T308 . .
or CCGT 09T308 . .

Geometry overview of turning inserts – positive basic shape

Medium machining

Geometry	Remarks/field of applications	Workpiece material group					
		P	M	K	N	S	H
		Steel	Stainless steel	Cast iron	NF metals	Materials with difficult cutting properties	Hard materials
 <p>PM</p> <ul style="list-style-type: none"> – Finishing with wiper technology – High surface quality – High feed rates <p>Wiper</p>		●●	●	●●		●	
 <p>PM2</p> <ul style="list-style-type: none"> – Universal insert for non-ferrous materials – Sharp cutting edge with fully ground circumference – Polished rake face – Precision finishing on steel and stainless materials 		●	●		●●	●	
 <p>PM5</p> <ul style="list-style-type: none"> – Universal geometry, medium machining to roughing – Extremely large chip breaking area 		●●	●●	●●		●	

Roughing



 <p>M0T</p> <ul style="list-style-type: none"> – Geometry especially for round inserts – Interrupted cuts 		●●		●			
 <p>PR5</p> <ul style="list-style-type: none"> – Geometry especially for round inserts – Heavy roughing – Heavy industry, e.g. railways 		●●		●			
 <p>CMW</p> <ul style="list-style-type: none"> – Cast iron machining with hard skin – Interrupted cuts – Stable cutting edge design 				●●			

- Primary application
- Other application

For ordering information, see the 2012 Walter complete catalogue.

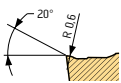
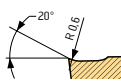
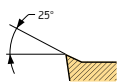
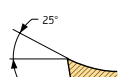
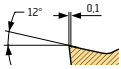
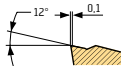

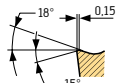
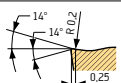
Cut Main cutting edge	Cut Corner radius	a_p [mm]	f [mm]
		0.5–4.0	0.12–0.60
		0.5–6.0	0.02–0.80
		0.6–5.0	0.12–0.50

		1.0–11.0	0.12–1.3
		1.0–15.0	0.20–1.7
		0.2–0.6	0.12–0.50

Comment: Cutting patterns show CCMT 09T308 . . . CCGT 09T308 . . .
CCMW 09T308 . . . or RCM . 2006 . . .

Technical information: Tool life

The three most important machining parameters – cutting speed, feed rate, and depth of cut – affect the tool life and tool life quantity.

Of these three, the depth of cut has the least negative affect, followed by the feed rate. The cutting speed has by far the greatest affect on the tool life of carbide indexable inserts.

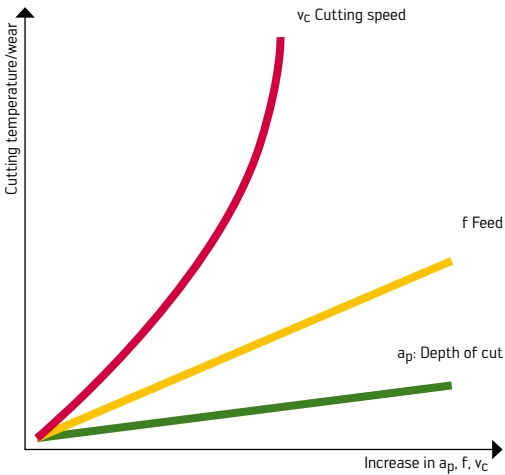

Sequence of measures to achieve an optimum tool life quantity:

1. Maximise depth of cut a_p
– Reduction in the number of cuts
2. Maximise feed rate f
– Shortening of the contact time
3. Adapt cutting speed v_c
– Reduction v_c : Decreased wear
– Increase v_c : Higher productivity

Technical information: Surface quality

ACHIEVABLE SURFACE FINISH QUALITY WITH STANDARD RADIUS

Select the largest possible corner radius permitted by the workpiece contour, system rigidity and chip control. The larger the corner radius, the better the surface quality that can be achieved.

		Theoretical Ra/Rz values depending on the feed rate and corner radius					
Corner radius mm	Round insert Ø mm	Ra/Rz in µm					
		0.4/1.6	1.6/6.3	3.2/12.5	6.3/25	8/32	32/100
		Feed f in mm					
0.2		0.05	0.08	0.13			
0.4		0.07	0.11	0.17	0.22		
0.8		0.10	0.15	0.24	0.30	0.38	
1.2			0.19	0.29	0.37	0.47	
1.6				0.34	0.43	0.54	1.08
2.4				0.42	0.53	0.66	1.32
	6	0.20	0.31	0.49	0.62		
	8	0.23	0.36	0.56	0.72		
	10	0.25	0.40	0.63	0.80	1.00	
	12		0.44	0.69	0.88	1.10	
	16		0.51	0.80	1.01	1.26	2.54
	20			0.89	1.13	1.42	2.94
	25				1.26	1.58	3.33

STANDARD FINISHING OPERATION

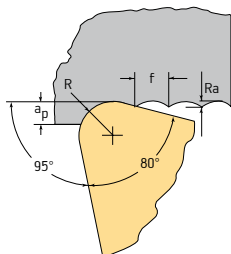

Roughness profile depth

$$R_{\max} = \frac{f^2}{8 \times r} \times 1000 \text{ [}\mu\text{m]}$$

Technical information: Hardness comparison table

Tensile strength [N/mm ²]	Vickers hardness	Brinell hardness	Rockwell hardness
Rm	HV	HB	HRC
255	80	76.0	
270	85	80.7	
285	90	85.5	
305	95	90.2	
320	100	95.0	
335	105	99.8	
350	110	105	
370	115	109	
385	120	114	
400	125	119	
415	130	124	
430	135	128	
450	140	133	
465	145	138	
480	150	143	
495	155	147	
510	160	152	
530	165	156	
545	170	162	
560	175	166	
575	180	171	
595	185	176	
610	190	181	
625	195	185	
640	200	190	
660	205	195	
675	210	199	
690	215	204	
705	220	209	
720	225	214	
740	230	219	
755	235	223	
770	240	228	20.3
785	245	233	21.3
800	250	238	22.2
820	255	242	23.1
835	260	247	24.0
850	265	252	24.8
865	270	257	25.6
880	275	261	26.4

Tensile strength [N/mm ²]	Vickers hardness	Brinell hardness	Rockwell hardness
Rm	HV	HB	HRC
900	280	266	27.1
915	285	271	27.8
930	290	276	28.5
950	295	280	29.2
965	300	285	29.8
995	310	295	31.0
1030	320	304	32.2
1060	330	314	33.3
1095	340	323	34.4
1125	350	333	35.5
1155	360	342	36.6
1190	370	352	37.7
1220	380	361	38.8
1255	390	371	39.8
1290	400	380	40.8
1320	410	390	41.8
1350	420	399	42.7
1385	430	409	43.6
1420	440	418	44.5
1455	450	428	45.3
1485	460	437	46.1
1520	470	447	46.9
1555	480	(456)	47.7
1595	490	(466)	48.4
1630	500	(475)	49.1
1665	510	(485)	49.8
1700	520	(494)	50.5
1740	530	(504)	51.1
1775	540	(513)	51.7
1810	550	(523)	52.3
1845	560	(532)	53.0
1880	570	(542)	53.6
1920	580	(551)	54.1
1955	590	(561)	54.7
1995	600	(570)	55.2

Tensile strength, Brinell, Vickers and Rockwell hardness (extract from DIN 50150)

Technical information: Turning calculation formulae

Tensile strength [N/mm ²]	Vickers hardness	Brinell hardness	Rockwell hardness
Rm	HV	HB	HRC
2030	610	(580)	55.7
2070	620	(589)	56.3
2105	630	(599)	56.8
2145	640	(608)	57.3
2180	650	(618)	57.8
	660		58.3
	670		58.8
	680		59.2
	690		59.7
	700		60.1
	720		61.0
	740		61.8
	760		62.5
	780		63.3
	800		64.0
	820		64.7
	840		65.3
	860		65.9
	880		66.4
	900		67.0
	920		67.5
	940		68.0

The hardness values converted according to these tables are only approximate. See DIN 50150.

Speed

$$n = \frac{v_c \times 1000}{D_c \times \pi} \quad [\text{rpm}]$$

Cutting speed

$$v_c = \frac{D_c \times \pi \times n}{1000} \quad [\text{m/min}]$$

Metal removal rate

$$Q = v_c \times a_p \times f \quad [\text{cm}^3/\text{min}]$$

Cutting time



$$t_h = \frac{l_m}{f \times n} \quad [\text{min}]$$



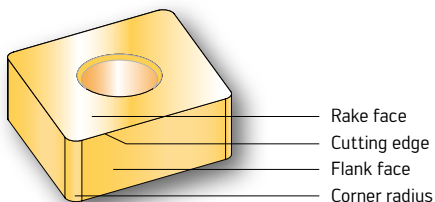

n	Speed	rpm
D _c	Cut diameter	mm
v _c	Cutting speed	m/min
v _f	Feed rate	mm/min
f	Feed per revolution	mm
a _p	Depth of cut	mm
t _h	Cutting time	min
l _m	Length of machining	mm

Tensile strength	N/mm ²	Rm
Vickers hardness	Diamond pyramid 136° Testing force F ≥ 98 N	HV
Brinell hardness Calculated from: HB = 0.95 x HV	0.102 x F/D ² = 30 N/mm ² F = Testing force in N D = Sphere diameter in mm	HB
Rockwell hardness C	Diamond cone 120° Overall testing force 1471 ± 9 N	HRC

Technical information: Wear patterns from turning



Types of wear	Characteristics	Action
<p>Flank face wear</p>  <p>The image shows a microscopic view of a tool's flank face with a dark, irregularly shaped wear zone. The diagram shows a cross-section of the tool with a shaded area on the flank face representing the wear.</p>	<p>Abrasion on the flank face of the indexable insert</p>	<ul style="list-style-type: none"> - Use a more wear-resistant cutting material - Increase the feed - Reduce the cutting speed - Optimise cooling
<p>Plastic deformation</p>  <p>The image shows a microscopic view of a tool's cutting edge with a dark, jagged, and deformed appearance. The diagram shows a cross-section of the tool with a shaded area on the cutting edge representing plastic deformation.</p>	<p>Deformation of the cutting edge due to thermal overload and high cutting forces</p>	<ul style="list-style-type: none"> - Use a more wear-resistant cutting material - Reduce the feed - Reduce the cutting depth - Optimise cooling - Reduce the cutting speed
<p>Fractures</p>  <p>The image shows a microscopic view of a tool's cutting edge with a dark, jagged, and fractured appearance. The diagram shows a cross-section of the tool with a shaded area on the cutting edge representing fractures.</p>	<p>Fractures along the cutting edge</p>	<ul style="list-style-type: none"> - Use tougher carbide grades - Use a more stable tool and reduce the projection length - Use more stable geometries - Reduce the cutting speed

Types of wear	Characteristics	Action
<p>Build-up on the cutting edge</p> 	<p>Adhesion of material along the cutting edge on the rake face</p>	<ul style="list-style-type: none"> - Increase the cutting speed - Use sharper geometry with a larger rake angle - Optimise cooling - Use an indexable insert with a treated surface (Tiger-tec®)
<p>Crater wear</p> 	<p>Crater-shaped cavities on the rake face of the indexable insert</p>	<ul style="list-style-type: none"> - Reduce the cutting speed - Use a geometry with a larger rake angle - Use a more open geometry - Use a cutting material that is more wear-resistant with high Al₂O₃ content - Optimise cooling
<p>Notching or oxidation wear</p> 	<p>Notching around the cutting depth on the indexable insert</p>	<ul style="list-style-type: none"> - Vary the cutting depth - Use a tough cutting material (PVD coated) - Reduce the cutting speed - Optimise cooling - Use a tool with a preceding cutting edge ($\kappa = 45^\circ/75^\circ$) - With notch wear, select a smaller corner radius
<p>Comb cracks</p> 	<p>Multiple cracks running vertical to the cutting edge, due to thermal shock</p>	<ul style="list-style-type: none"> - Possibly work the interrupted cut without coolant - Reduce the cutting speed - Reduce feed - Use a tougher cutting material - Use more stable geometries

 WALTER



Up to
75%
increase in
output

Tiger-tec[®] Silver

Walter AG

Derendinger Str. 53, 72072 Tübingen
Postfach 2049, 72010 Tübingen
Germany

www.walter-tools.com

www.facebook.com/waltertools

www.youtube.com/waltertools

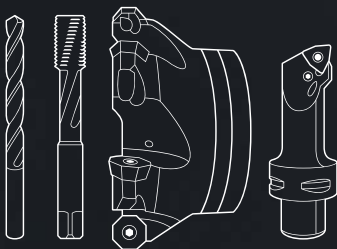

Walter GB LTD.

Bromsgrove, England
+44 (1527) 839 450, service.uk@walter-tools.com

Walter Kesici Takımlar Sanayi ve Ticaret Limited Sirketi

Istanbul, Turkey
+90 (216) 528 1900 Pbx, service.tr@walter-tools.com

Walter Wuxi Co. Ltd.

Wuxi, Jiangsu, P.R. China
+86 (510) 8241 9399, service.cn@walter-tools.com

Walter AG Singapore Pte. Ltd.

+65 6773 6180, service.sg@walter-tools.com

Walter Korea Ltd.

Ansan, Kyungki-do, Korea
+82 (31) 3646 100, service.kr@walter-tools.com

Walter Tools India Pvt. Ltd.

Pune, India
+91 (20) 3045 7300, service.in@walter-tools.com

Walter (Thailand) Co., Ltd.

Bangkok, 10120, Thailand
+66 2 687 0388, service.th@walter-tools.com

Walter Malaysia Sdn. Bhd.

Selangor D.E., Malaysia
+60 (3) 8023 7748, service.my@walter-tools.com

Walter Australia Pty. Ltd.

Hallam, Victoria 3803, Australia
+61 3 8793 1000, service.au@walter-tools.com

Walter Tooling Japan K.K.

Nagoya, Japan
+81 (52) 723 5800, service.jp@walter-tools.com

Walter USA, LLC

Waukesha (WI), USA
+1 800-945-5554, service.us@walter-tools.com

TDM Systems Inc.

Schaumburg (IL), USA
+1 (847) 605 1269, info@tdmsystems.com

Walter Tools S.A. de C.V.

Saltillo, Coahuila, Mexico
+52 (844) 450-3500, service.mx@walter-tools.com

Walter Canada

Mississauga, Canada
service.ca@walter-tools.com
